

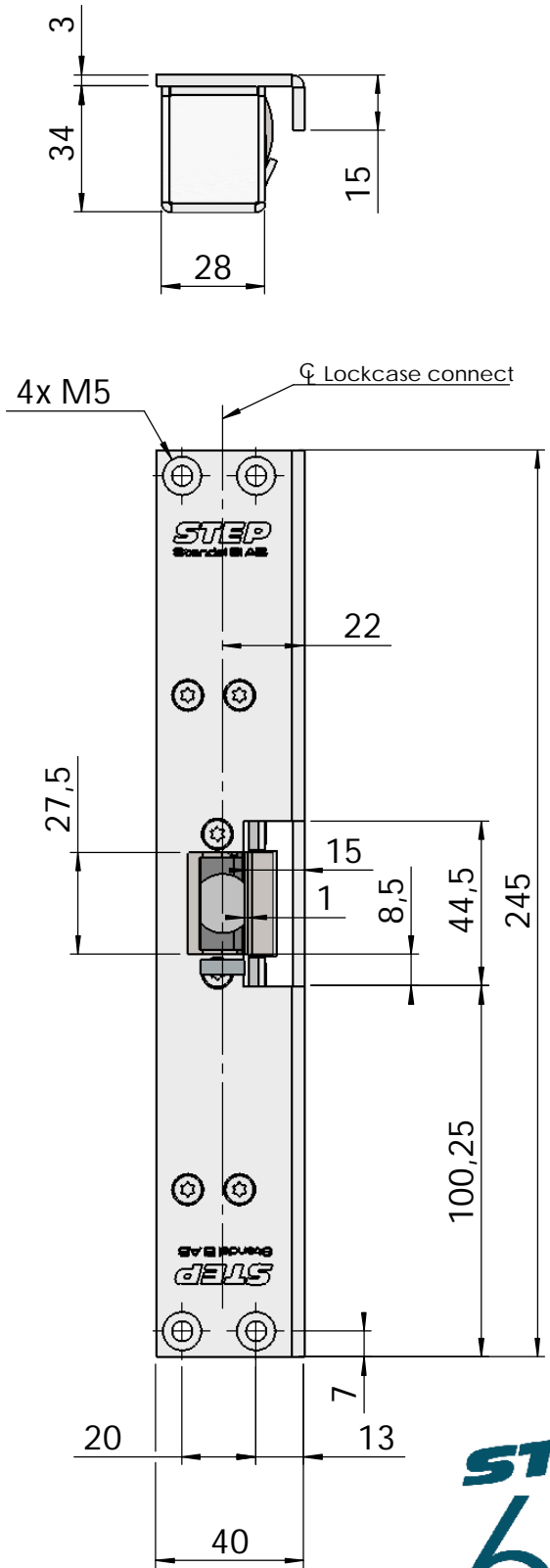

Montering för Connect

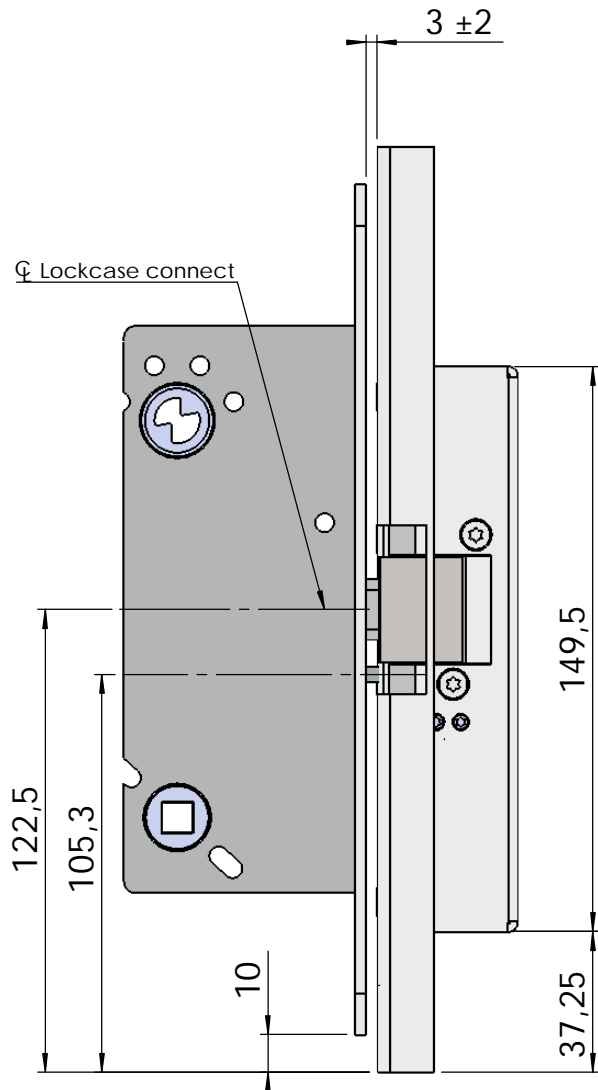

This document shall not be copied without owners written allowance and its content shall not be exposed for third part nor be used for unauthorized purpose.

Owner
Stendals EI AB

Title/Description
STEP 60 med vinklad stolpe plös 15mm
Montering för Connect

Drawing no.
ST6545

Scale
1:2



Montering för Modul

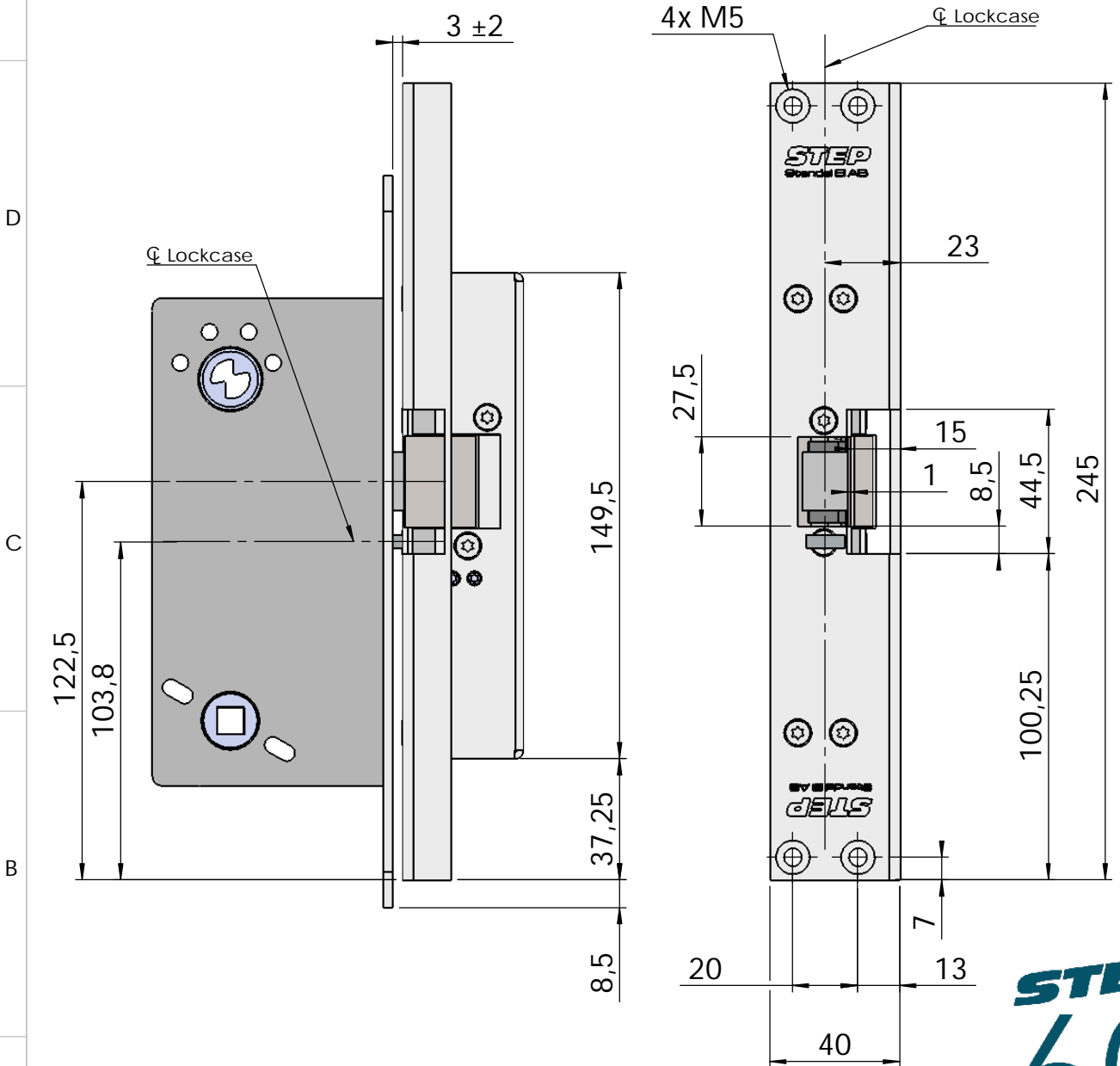
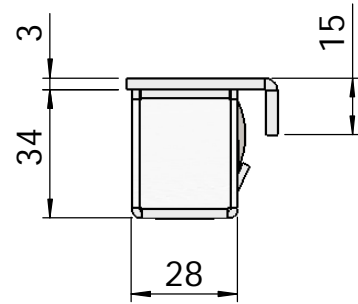

This document shall not be copied without owners written allowance and its content shall not be exposed for third part nor be used for unauthorized purpose.

Owner Stendals EI AB	Title/Description STEP 60 med vinklad stolpe plös 15mm Montering för Modul
	Drawing no. ST6545 Scale 1:2