

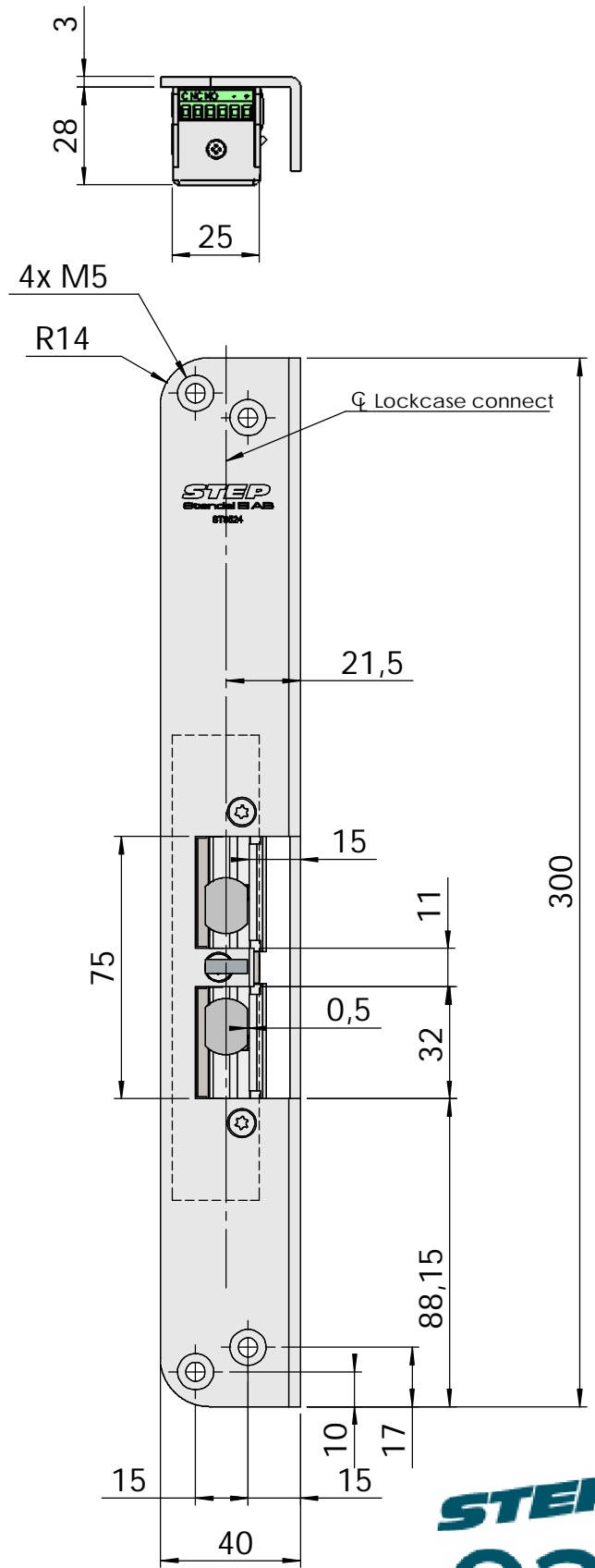

Montering för Connect

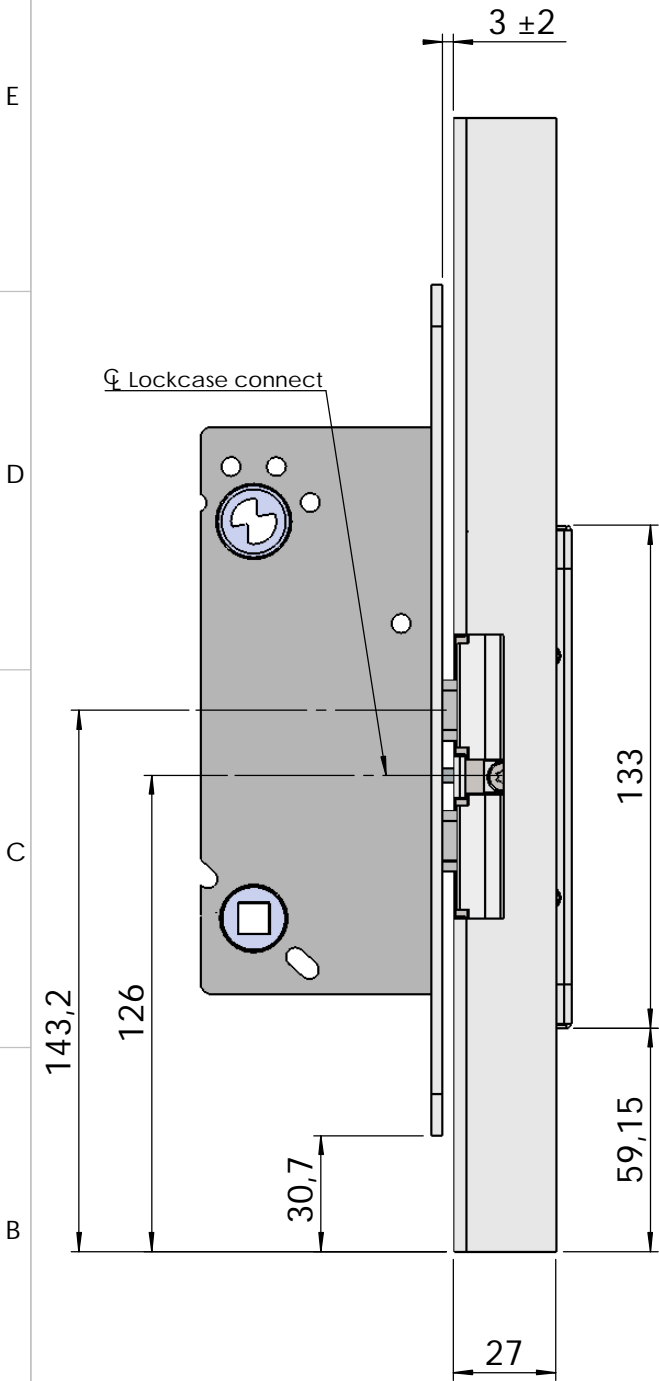

This document shall not be copied without owners written allowance and its content shall not be exposed for third part nor be used for unauthorized purpose.

Owner Stendals EI AB	Title/Description STEP 92 med vinklad stolpe plös 15mm Montering för Connect
	Drawing no. ST9524 Scale 1:2



Montering för Modul

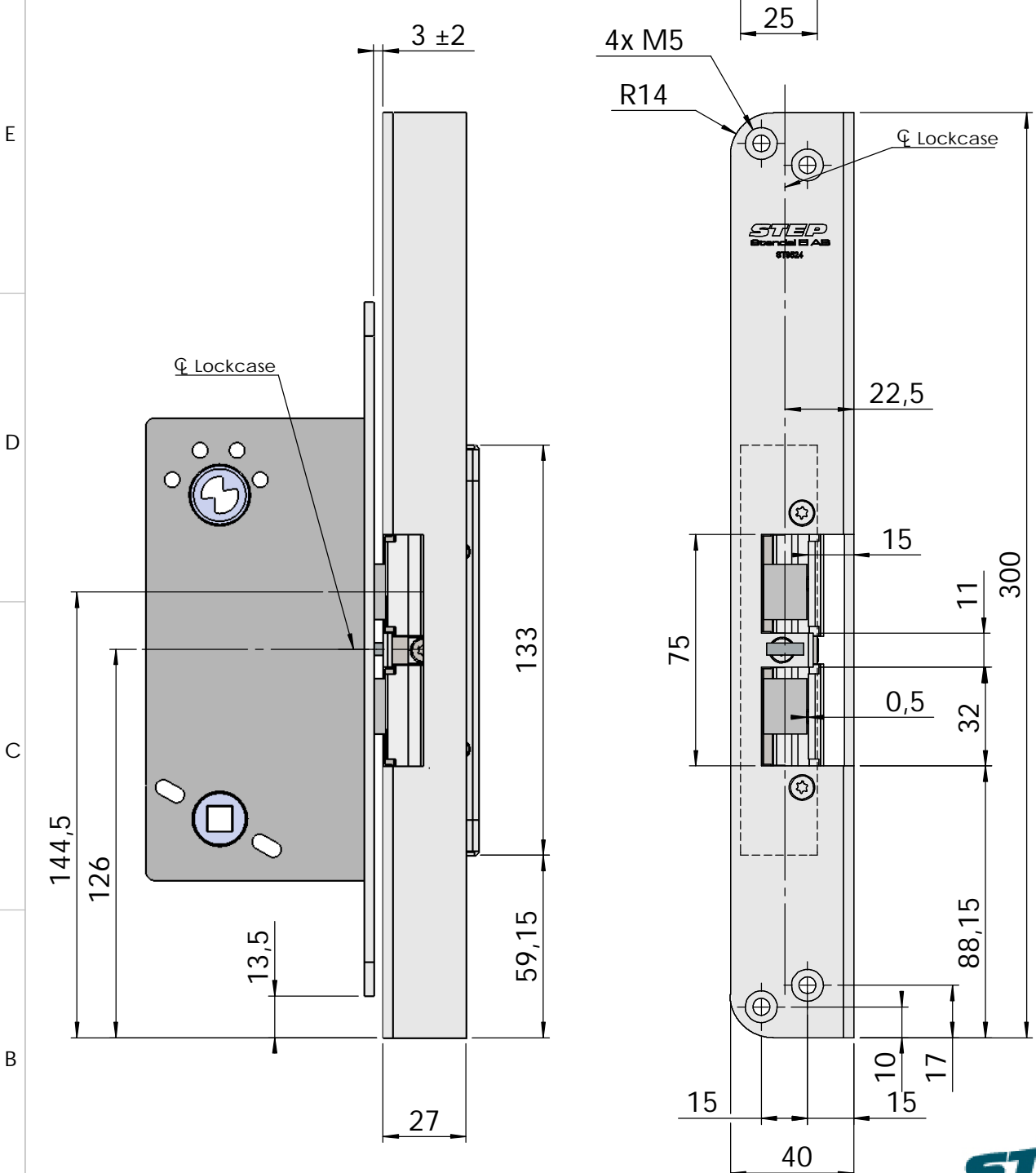

This document shall not be copied without owners written allowance and its content shall not be exposed for third part nor be used for unauthorized purpose.

Owner
Stendals EI AB

Title/Description
STEP 92 med vinklad stolpe plös 15mm
Montering för Modul

Drawing no.
ST9524

Scale
1:2

